





Messrs.					
Product Specification	Model:	MTF-T070ACSLP-LB	Rev. No.	Issued Date.	Page.
			E	Oct.19, 07	1 / 23

LIQUID CRYSTAL DISPLAY MODULE
MODEL: MTF-T070ACSLP-LB
Customer's No.:

Acceptance

Microtips Technology Inc.
 12F. No.31 Lane 169, Kang Ning St.,
 His-Chih, Taipei Hsien, Taiwan
 FAX: 886-2-26958625

Approved and Checked by

Approved by	Checked by		Made by
			



Microtips Technology Inc.

Messrs.					
Product Specification	Model:	MTF-T070ACSLP-LB	Rev. No.	Issued Date.	Page.
			<i>E</i>	<i>Oct.19, 07</i>	<i>3 / 23</i>

Contents

1.	GENERAL DESCRIPTION AND FEATURES	4
1.1	Features.....	4
1.2	LCD Module	4
2.	ELECTRICAL SPECIFICATIONS	5
2.1	Absolute Max. Ratings.....	5
2.2	Electrical Characteristics.....	6
2.3	Power Signal Sequence.....	7
3.	OPTICAL CHARACTERISTICS	8
3.1	Optical characteristic of the LCD.....	8
4.	INPUT SIGNAL (DE ONLY MODE)	12
4.1	Timing Specification	12
4.2	Timing sequence(Timing chart).....	13
5.	PIN ASSIGNMENT	14
5.1	Pin Assignment (Connector type: 40pin/ 0.5mm pitch/ Bottom contact)-0.....	14
5.2	Block Diagram	16
5.3	Touch Panel.....	16
6.	DISPLAYED COLOR AND INPUT DATA	17
7.	TEST	18
8.	PRECAUTIONS	19
8.1	Operation	19
8.2	Safety	19
8.3	Handling.....	19
8.4	Static electricity	21
8.5	Storage	21
8.6	Cleaning.....	21
8.7	Waste.....	21
9.	WARRANTY	22
10.	DIMENSIONAL OUTLINES	22



Messrs.					
Product Specification	Model:	MTF-T070ACSLP-LB	Rev. No.	Issued Date.	Page.
			<i>E</i>	<i>Oct.19, 07</i>	<i>4 / 23</i>

1. GENERAL DESCRIPTION AND FEATURES

MTF-T070ACSLP-LB is a transmissive type color active matrix TFT (Thin Film Transistor) liquid crystal display (LCD) that uses amorphous silicon TFT as a switching devices. This model is composed of a TFT-LCD module, a driver ICs, control circuit, touch panel and a back-light unit. Graphics and texts can be displayed on a WVGA 800 (W) x 3 x 480 (H) dots (16:9 aspect ratio) with 262,144 colors by supplying 18 bits data signal (6 bits RGB signal input). The following table described the features of MTF-T070ACSLP-LB.

1.1 Features

- Transmissive and back-light with the LED.
- Using the Touch Screen Panel (Film to Film-Plastic type)
- TN (Twisted Nematic) mode.
- Digital RGB 6 bits TTL data signal input.
- Data enable mode.
- Data inverted function for reducing EMI.

1.2 LCD Module

Item	Specification	Unit
Screen Size	7.0 inches	Diagonal
Display Resolution	800 (H) x 480 (V)	Dots
Display Area	152.40 (H) x 91.44 (V)	mm
Outline Dimension	165.00 (H) x 104.00 (V) x 6.5 (T) Including touch panel, but excluding the FPCB tail and the connectors at the backside.	mm
Pixel Pitch	0.1905 x 0.1905	mm
Display Mode	Normally white mode/ Transmissive	--
Pixel Arrangement	R,G,B Vertical Tripe	--
Surface Treatment	Anti-Glare, Hardness:3H	--
Response Time (Tr+Tf)	20ms	--
Display Color	Full Colors	--
Viewing Direction	6 o'clock	--
Input Interface	Digital 6 bits TTL data signal input	--
BL Unit	LED	--
Weight	TBD	--



Messrs.					
Product Specification	Model:	MTF-T070ACSLP-LB	Rev. No.	Issued Date.	Page.
			E	Oct.19, 07	5 / 23

2. ELECTRICAL SPECIFICATIONS

2.1 Absolute Max. Ratings

2.1.1 Absolute Ratings of Environment

If the operating condition exceeds the following absolute maximum ratings, the TFT LCD module may be damaged permanently.

Item	Symbol	Min.	Max.	Unit	Note
Power supply voltage for LCD	V _{CC}	-0.5	5.0	V	
Signal input voltage	DCLK, DE, R0, G0, B0-R5, G5, B5	-0.5	V _{CC} +0.5	V	
Storage temperature	T _{STG}	-40	95	°C	(1)
Operating temperature	T _{OPR}	-30	85	°C	(1)
ICC Rush Current	IRUSH	-	1	A	(3)
Static electricity	VESDc	-200	+200	V	
	VESDm	-15K	+15K	V	

Notes :

*1) If users use the product out off the environment operation range (temperature and humidity) ,it will concern for visual quality.

*2) Test Condition: IEC 61000-4-2 ,

VESDc : Contact discharge to input connector

VESDm : Contact discharge to module

Control signal: High (+3.3V) → Low(GND)

Supply Voltage of rising time should be from R3 and C2 tune to 550 us.

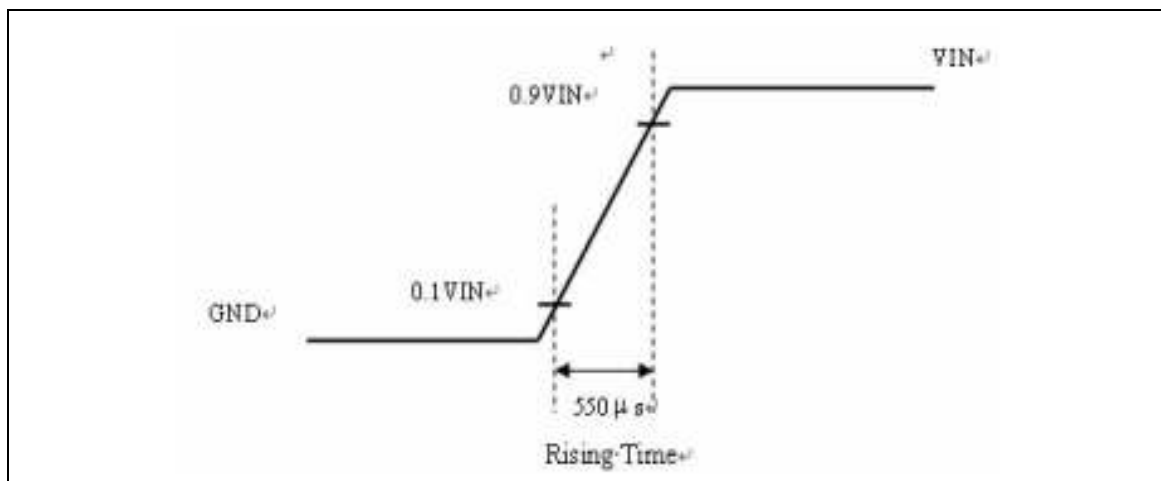

Microtips Technology Inc.

Messrs.					
Product Specification	Model:	MTF-T070ACSLP-LB	Rev. No.	Issued Date.	Page.
			E	Oct.19, 07	6 / 23

2.2 Electrical Characteristics

2.2.1 TFT LCD

Item	Symbol	Min	Typ	Max	Unit	Note
Power Supply Voltage for Digital Circuit	VCC	3.0	3.3	3.6	V	1
Power Supply Voltage for Analog Circuit	VDD	4.5	5	5.5	V	-
Logic Input Voltage	VIH	VCC*0.7	-	VCC	V	-
	VIL	0	-	VCC*0.3	V	-

Remarks :

*1)VCC - dip codition:

1) When $2.7\text{ V} \leq \text{VCC} < 3.0\text{V}$, $t_d \leq 10\text{ms}$.

2) $\text{VCC} > 3.0\text{V}$, VCC-dip condition should be same as VCC-turn-on condition.

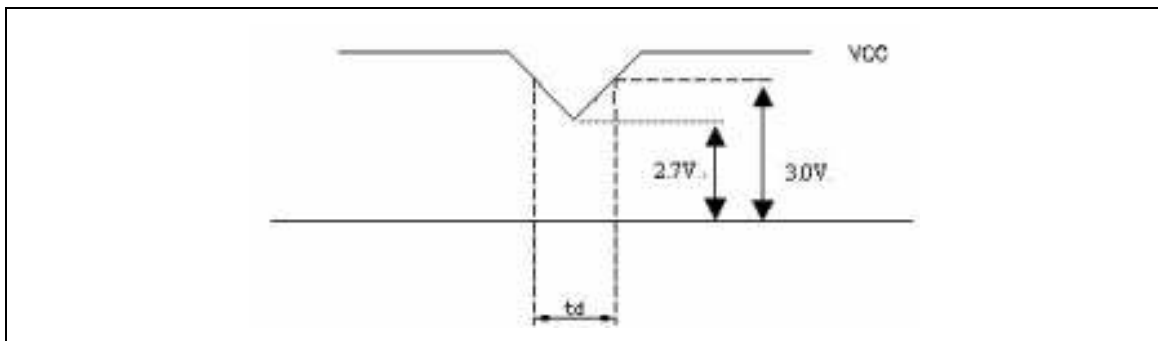

2.2.2 TFT-LCD current Consumption

Item	Symbol	Min	Typ	Max	Unit	Note
LCD power current	ICC	-	150	200	mA	1
LED power current	IDD	-	300	350	mA	2

Note:

*1) Typical: Under 64 gray pattern

Maximum: Under black pattern



(a) 64 Gray Pattern (b) Black Pattern

*2) Typical: When VDD is 5V

Maximum: When VDD is 4.5V



Microtips Technology Inc.

Messrs.					
Product Specification	Model:	MTF-T070ACSLP-LB	Rev. No.	Issued Date.	Page.
			E	Oct.19, 07	7 / 23

2.3 Power Signal Sequence

- $t1 \leq 10\text{ms}$ $1 \text{ sec} \leq t5$
- $50\text{ms} \leq t2$ $200\text{ms} \leq t6$
- $0 < t3 \leq 50\text{ms}$ $200\text{ms} \leq t7$
- $0 < t4 \leq 10\text{ms}$

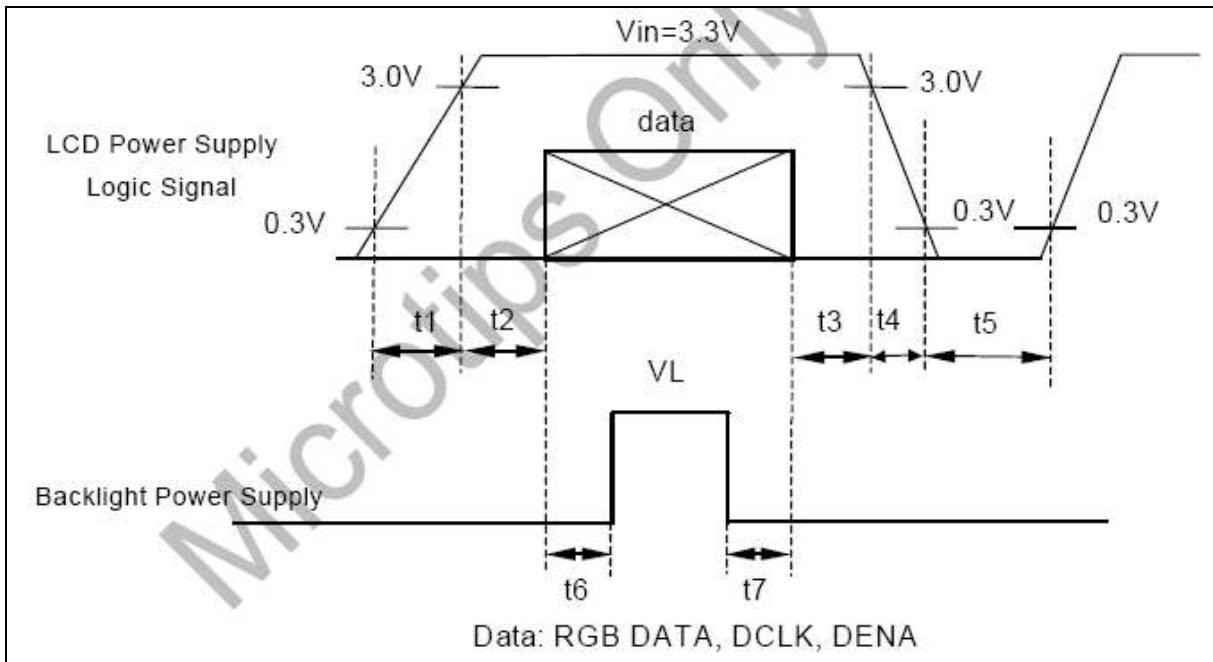

Messrs.					
Product Specification	Model:	MTF-T070ACSLP-LB	Rev. No.	Issued Date.	Page.
			<i>E</i>	<i>Oct.19, 07</i>	<i>8 / 23</i>

3. OPTICAL CHARACTERISTICS

3.1 Optical characteristic of the LCD

The following items are measured under stable conditions. The optical characteristics should be measured in a dark room or equivalent state with the methods shown in Note (1).

Measuring equipment: LCD-5000, BM-5A, BM-7, PR-650, EZ-Contrast

Item		Symbol	Condition	Min	Type	Max	Unit	Note
Brightness		--	$I_L=300\text{mA}$	--	180	--	cd/m^2	--
Response time		T_R+T_F	$\theta=0^\circ$	--	--	20	ms	Note.
Contrast ratio		CR	At optimized viewing angle	300	400	--	--	Note.
Color Chromaticity (CIE 1931)	Red	R_X	$\theta=0^\circ$ Normal Viewing Angle	TBD	TBD	TBD	--	Note.
		R_Y		TBD	TBD	TBD		
	Green	G_X		TBD	TBD	TBD	--	
		G_Y		TBD	TBD	TBD		
	Blue	B_X		TBD	TBD	TBD	--	
		B_Y		TBD	TBD	TBD		
	White	W_X		0.273	0.313	0.353	--	
		W_Y		0.289	0.329	0.369		
Viewing Angle (6H)	Hor.	θ_R θ_L	$CR \geq 10$	120	140	--	Degree	Note.
	Ver.	ϕ_H ϕ_L		90	110	--		



Messrs.					
Product Specification	Model:	MTF-T070ACSLP-LB	Rev. No.	Issued Date.	Page.
			E	Oct.19, 07	9 / 23

a. Test equipment setup

After stabilizing and leaving the panel alone at a given temperature for 30 minutes, the measurement should be executed. Measurement should be executed in a stable, windless, and dark room. Optical specifications are measured by Topcon BM-7(fast) with a viewing angle of 2° at a distance of 50cm and normal direction.

b. Definition of response time: TR and TF

The response time is defined as the following figure and shall be measured by switching the input signal for "black" and "white".

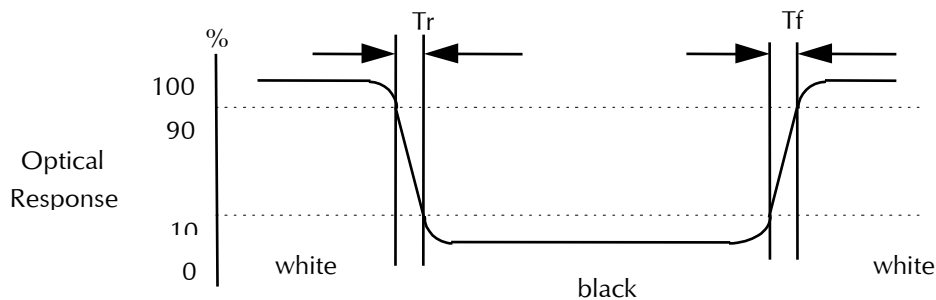

c. Definition of contrast ratio:

$$\text{Contrast Ratio (CR)} = \frac{\text{Brightness measured when LCD is at "white state"}}{\text{Brightness measured when LCD is at "black state"}}$$

White $V_i = V_{i50\%} \pm 1.5V$

Black $V_i = V_{i50\%} m 2.0V$

"±" means that the analog input signal swings in phase with V_{COM} signal.

"m" means that the analog input signal swings out of phase with V_{COM} signal.

$V_{i50\%}$: The analog input voltage when transmission is 50%.

The 100% transmission is defined as the transmission of LCD panel when all the input terminals of module are electrically opened.

d. Measured at the center area of the panel when all the input terminals of LCD panel are electrically opened.



Microtips Technology Inc.

Messrs.					
Product Specification	Model:	MTF-T070ACSLP-LB	Rev. No.	Issued Date.	Page.
			E	Oct.19, 07	10 / 23

e. View Angle

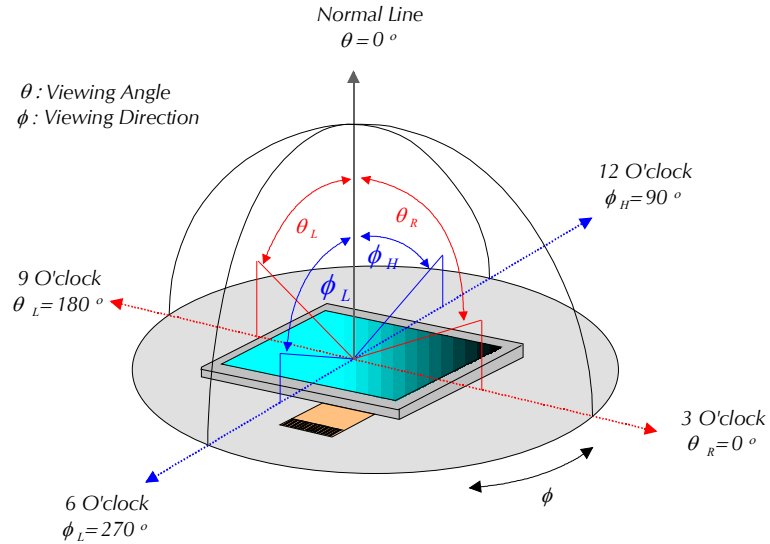

f. Definition of Luminance of White: Luminance of white at the center points

Light Source of Back-Light Unit	LED Type
---------------------------------	----------

g. Definition of White Uniformity

$$\text{White Uniformity} = \frac{\text{Min. luminance of white among 5-points}}{\text{Max. luminance of white among 5-points}} \times 100\%$$

h. The definition of Color Gamut -Color Chromaticity CIE 1931 (Graphic-7)

Color coordinate of white & red, green, blue at center point.

$$\text{Color Gamut : } S(\%) = (\text{RGB Triangle Area} / \text{NTSC Triangle Area}) \times 100$$

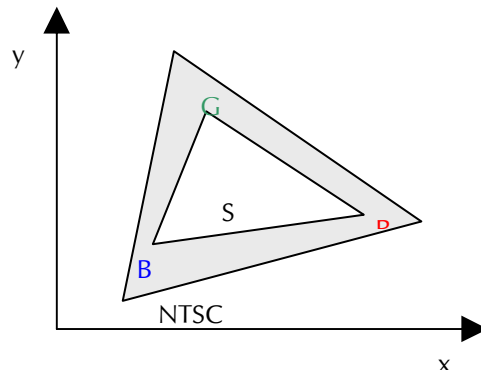

Messrs.					
Product Specification	Model:	MTF-T070ACSLP-LB	Rev. No.	Issued Date.	Page.
			E	Oct.19, 07	11 / 23

i. Optical Measurement and Equipment

Reflective Mode

The Measuring condition and equipments for this mode are below:

Measuring condition

- $l = 550\text{mm}$ (typical), 1000mm (max) / d & The θ : No emission of light-source with angle from Lamp or others
- Light source : Standard C light-source (Solar light)
- Dark room : Not essential (Required exclusion of direct light effecting on the sample)

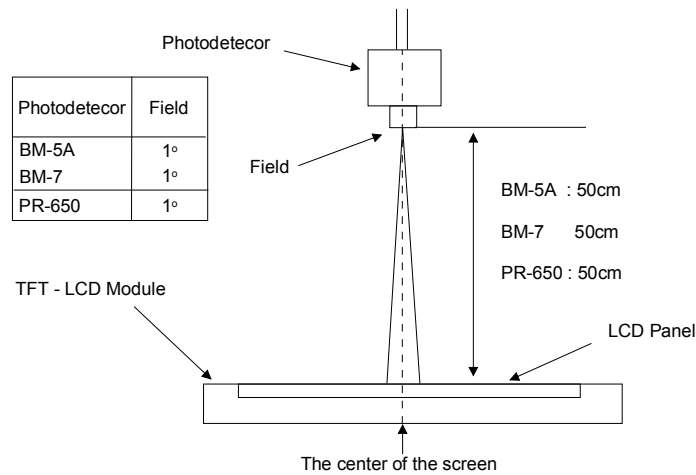

Transmissive Mode

No equipment available

Brightness Measurement Point

The Measuring condition and equipments for the brightness of LED Backlight are below:

- Measuring condition

- Measuring after LED's are turned on for 5 minutes
- Spot size = 2mm
- Distance between module and equipment = 550mm



Messrs.					
Product Specification	Model:	MTF-T070ACSLP-LB	Rev. No.	Issued Date.	Page.
			E	Oct.19, 07	12 / 23

4. INPUT SIGNAL (DE ONLY MODE)

4.1 Timing Specification

Item		Symbol	Min	Typ	Max	Unit
DCLK	Period	tCLK	31	37.0	40.0	ns
	Dot Colck	fCLK	25	27	32.11	MHz
	Low Level Width	tWCL	6	-	-	ns
	High Level Width	tWCH	6	-	-	
DE	Setup Time	tDES	5	-	-	ns
	Hold Time	tDEH	10	-	-	tCLK
	Horizontal Period	tHP	850	900	950	
	Horizontal Valid	tHV	800			
	Horizontal Blank	tHBK	50	100	150	
	Vertical Period	tVP	490	500	520	tHP
	Vertical Valid	tVV	480			
	Vertical Blank	tVBK	10	20	40	
	Vertical Frequency	fV	55	60	65	Hz
DATA	Setup Time	tDS	5	-	-	ns
	Hold Time	tDH	10	-	-	

Note:

*1) High level of logic signal is 80% ◦ Low level of logic signal is 20% ◦

*2) This module is operated by DE only mode



Messrs.

Product Specification	Model:	MTF-T070ACSLP-LB	Rev. No.	Issued Date.	Page.
			E	Oct.19, 07	13 / 23

4.2 Timing sequence(Timing chart)

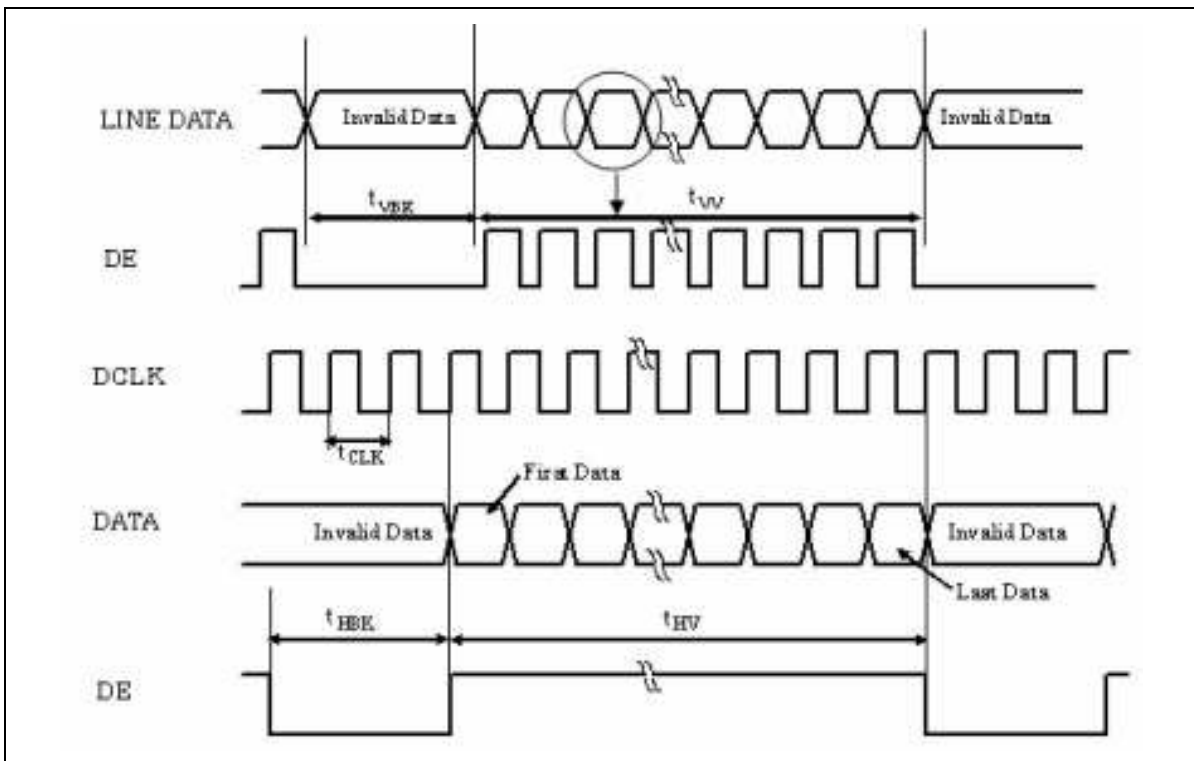
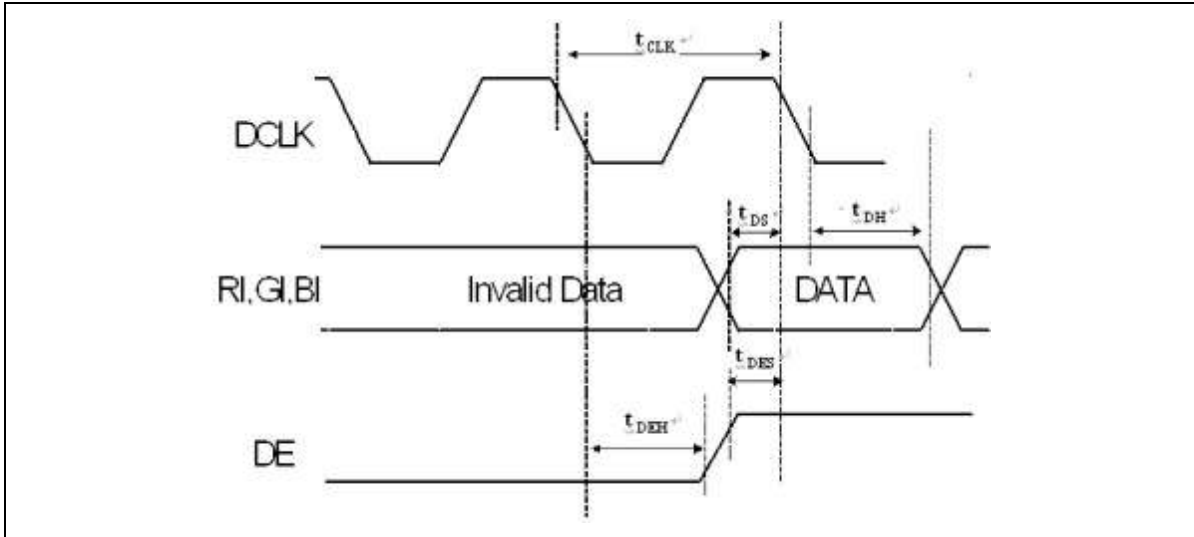

Microtips Technology Inc.

Messrs.					
Product Specification	Model:	MTF-T070ACSLP-LB	Rev. No.	Issued Date.	Page.
			E	Oct.19, 07	14 / 23

5. PIN ASSIGNMENT

5.1 Pin Assignment (Connector type: 40pin/ 0.5mm pitch/ Bottom contact)-089n40-000r00-g2)

Pin No.	Symbol	I/O	Function	Remark
1	V _{SS}	-	Ground	
2	V _{SS}	-	Ground	
3	ADJ	-	Brightness Control for LED B/L (3.3V)	
4	V _{DD}	-	Power Supply for Analog circuit (5V)	
5	V _{DD}	-	Power Supply for Analog circuit (5V)	
6	V _{DD}	-	Power Supply for Analog circuit (5V)	
7	V _{CC}	-	Power Supply for Digital Circuit (3.3V)	
8	V _{CC}	-	Power Supply for Digital Circuit (3.3V)	
9	DE	-	Data Enable	
10	V _{SS}	-	Ground	
11	V _{SS}	-	Ground	
12	V _{SS}	-	Ground	
13	B5	I	Blue Data 5 (MSB)	
14	B4	I	Blue Data 4	
15	B3	I	Blue Data 3	
16	V _{SS}	-	Ground	
17	B2	I	Blue Data 2	
18	B1	I	Blue Data 1	
19	B0	I	Blue Data 0 (LSB)	
20	V _{SS}	-	Ground	
21	G5	I	Green Data 5 (MSB)	
22	G4	I	Green Data 4	
23	G3	I	Green Data 3	
24	V _{SS}	-	Ground	
25	G2	I	Green Data 2	
26	G1	I	Green Data 1	
27	G0	I	Green Data 0 (LSB)	
28	V _{SS}	-	Ground	
29	R5	I	Red Data 5 (MSB)	
30	R4	I	Red Data 4	
31	R3	I	Red Data 3	
32	V _{SS}	-	Ground	
33	R2	I	Red Data 2	
34	R1	I	Red Data 1	
35	R0	I	Red Data 0	
36	V _{SS}	-	Ground	
37	V _{SS}	-	Ground	
38	DCLK	I	Data Clock	
39	V _{SS}	-	Ground	
40	V _{SS}	-	Ground	



Messrs.					
Product Specification	Model:	MTF-T070ACSLP-LB	Rev. No.	Issued Date.	Page.
			E	Oct.19, 07	15 / 23

TSP Pin Assignment

Pin No.	DESIGNATION
1	YU
2	XR
3	YD
4	XL

Note :

1). ADJ adjust brightness to control Pin , Pulse duty the more small the more bright

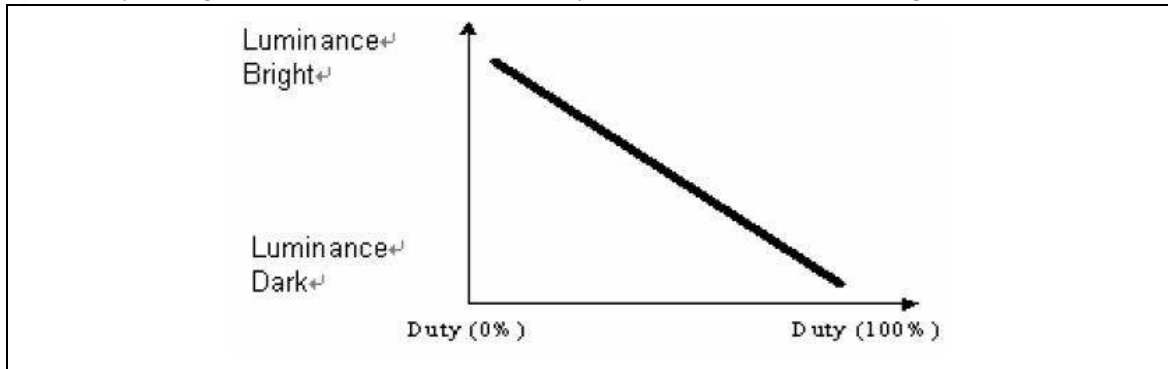

2) ADJ signal =0~3.3V , operation frequency:20KHZ±5KHZ

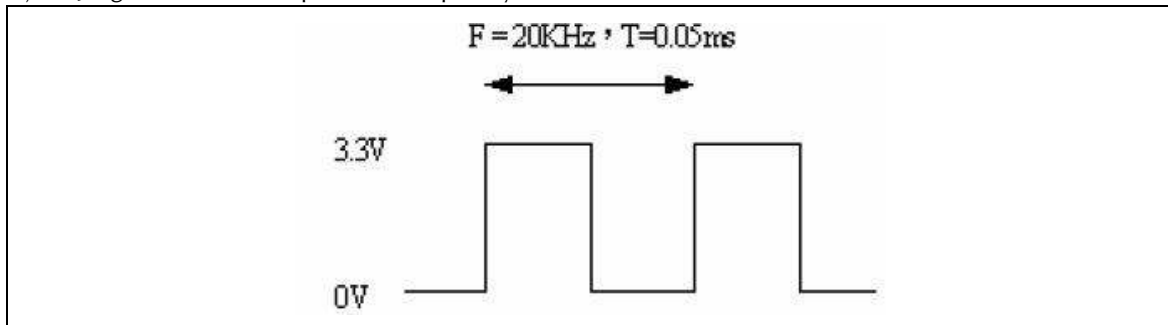

Messrs.					
Product Specification	Model:	MTF-T070ACSLP-LB	Rev. No.	Issued Date.	Page.
			E	Oct.19, 07	16 / 23

5.2 Block Diagram

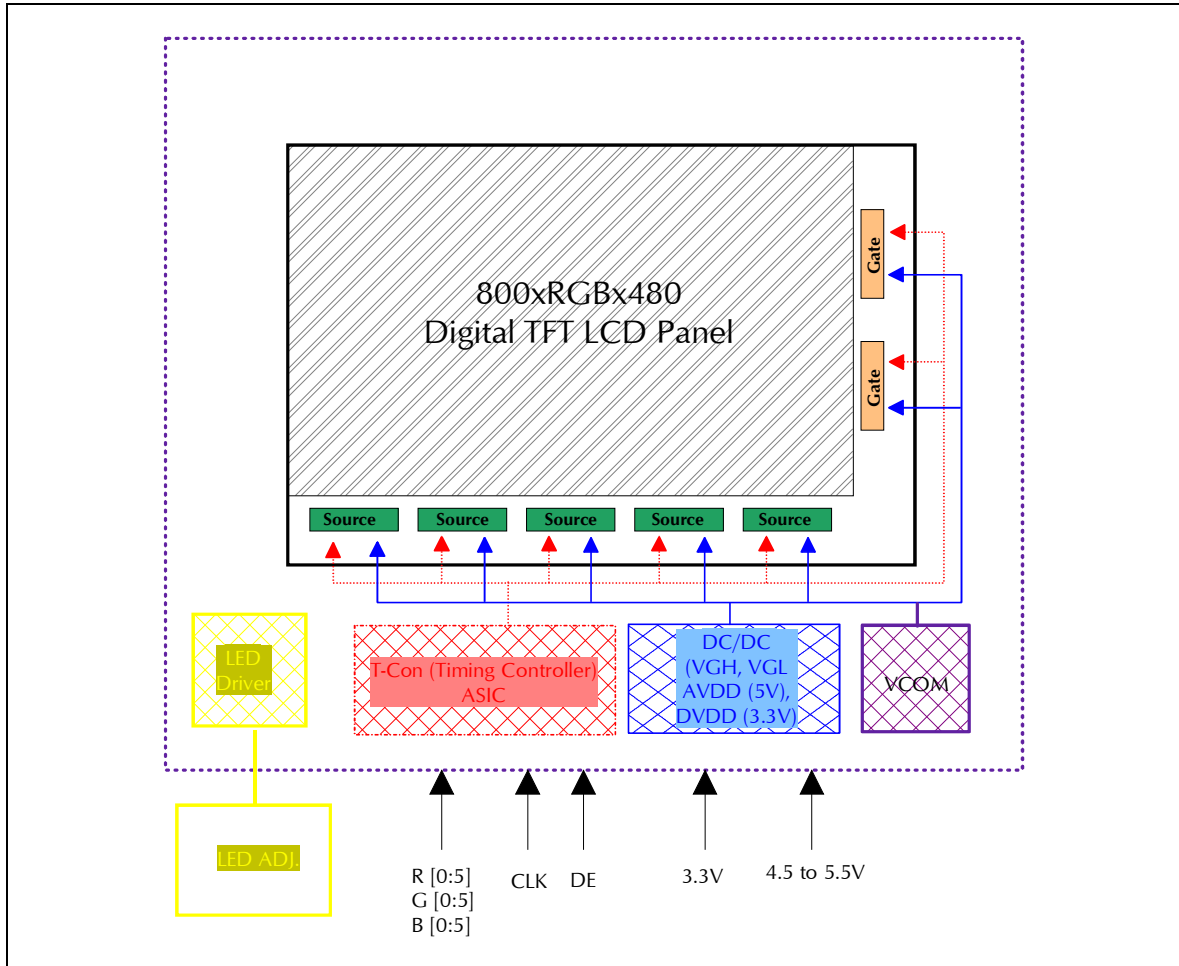

5.3 Touch Panel

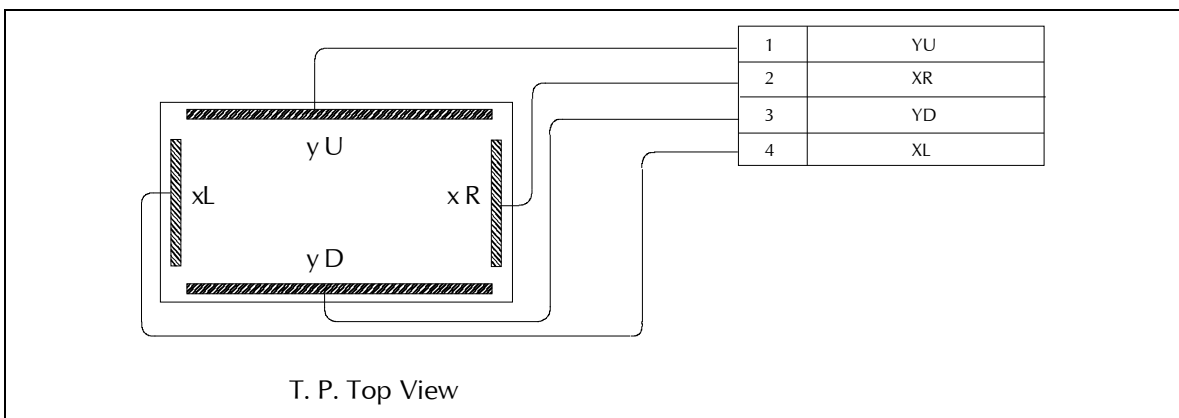

Messrs.					
Product Specification	Model:	MTF-T070ACSLP-LB	Rev. No.	Issued Date.	Page.
			E	Oct.19, 07	17 / 23

6. DISPLAYED COLOR AND INPUT DATA

	Color & Gray Scale	Data Signal																	
		R5	R4	R3	R2	R1	R0	G5	G4	G3	G2	G1	G0	B5	B4	B3	B2	B1	B0
Basic Color	Black	0	0	0	0	0	0	0	0	0	0	0	0	0	0	0	0	0	0
	Red(0)	1	1	1	1	1	1	0	0	0	0	0	0	0	0	0	0	0	0
	Green(0)	0	0	0	0	0	0	1	1	1	1	1	1	0	0	0	0	0	0
	Blue(0)	0	0	0	0	0	0	0	0	0	0	0	0	1	1	1	1	1	1
	Cyan	0	0	0	0	0	0	1	1	1	1	1	1	1	1	1	1	1	1
	Magenta	1	1	1	1	1	1	0	0	0	0	0	0	1	1	1	1	1	1
	Yellow	1	1	1	1	1	1	1	1	1	1	1	1	0	0	0	0	0	0
	White	1	1	1	1	1	1	1	1	1	1	1	1	1	1	1	1	1	1
Red	Black	0	0	0	0	0	0	0	0	0	0	0	0	0	0	0	0	0	0
	Red(62)	0	0	0	0	0	1	0	0	0	0	0	0	0	0	0	0	0	0
	Red(61)	0	0	0	0	1	0	0	0	0	0	0	0	0	0	0	0	0	0
	:	:	:	:	:	:	:	:	:	:	:	:	:	:	:	:	:	:	:
	Red(31)	0	1	1	1	1	1	0	0	0	0	0	0	0	0	0	0	0	0
	:	:	:	:	:	:	:	:	:	:	:	:	:	:	:	:	:	:	:
	Red(1)	1	1	1	1	1	0	0	0	0	0	0	0	0	0	0	0	0	0
	Red(0)	1	1	1	1	1	1	0	0	0	0	0	0	0	0	0	0	0	0
Green	Black	0	0	0	0	0	0	0	0	0	0	0	0	0	0	0	0	0	0
	Green(62)	0	0	0	0	0	0	0	0	0	0	0	1	0	0	0	0	0	0
	Green(61)	0	0	0	0	0	0	0	0	0	0	1	0	0	0	0	0	0	0
	:	:	:	:	:	:	:	:	:	:	:	:	:	:	:	:	:	:	:
	Green(31)	0	0	0	0	0	0	0	1	1	1	1	0	0	0	0	0	0	0
	:	:	:	:	:	:	:	:	:	:	:	:	:	:	:	:	:	:	:
	Green(1)	0	0	0	0	0	0	1	1	1	1	1	0	0	0	0	0	0	0
	Green(0)	0	0	0	0	0	0	1	1	1	1	1	1	0	0	0	0	0	0
Blue	Black	0	0	0	0	0	0	0	0	0	0	0	0	0	0	0	0	0	0
	Blue(62)	0	0	0	0	0	0	0	0	0	0	0	0	0	0	0	0	0	1
	Blue(61)	0	0	0	0	0	0	0	0	0	0	0	0	0	0	0	0	1	0
	:	:	:	:	:	:	:	:	:	:	:	:	:	:	:	:	:	:	:
	Blue(31)	0	0	0	0	0	0	0	0	0	0	0	0	0	1	1	1	1	1
	:	:	:	:	:	:	:	:	:	:	:	:	:	:	:	:	:	:	:
	Blue(1)	0	0	0	0	0	0	0	0	0	0	0	0	1	1	1	1	1	0
	Blue(0)	0	0	0	0	0	0	0	0	0	0	0	0	1	1	1	1	1	1

0 : Low level voltage, 1 :High level voltage

Each basic color can be displayed in 64 gray scales from 6 bit data signals. With the combination of total 18 bit data signals, the 262,144-color display can be achieved on the screen.



Messrs.					
Product Specification	Model:	MTF-T070ACSLP-LB	Rev. No.	Issued Date.	Page.
			<i>E</i>	<i>Oct.19, 07</i>	<i>18 / 23</i>

7. TEST

No change on display and in operation under the following test condition.

Condition: Unless otherwise specified, tests will be conducted under the following condition.

Temperature: 20±25°C

Humidity: 65±5%RH

Tests will be not conducted under functioning state.

No.	Parameter	Condition	Notes
1	High Temperature Operating	85°C±2°C, 240hrs (Operation state)	
2	Low Temperature Operating	-30°C±2°C, 240hrs (Operation state)	
3	High Temperature Storage	95°C±2°C, 240hrs	
4	Low Temperature Storage	-40°C±2°C, 240hrs	
5	Vibration Test (non-operation)	Total fixed amplitude: 1.3mm Vibration Frequency: 8~33.3Hz Sweep:2.9G,33.3Hz-400Hz Cycle:15min	
6	Shock Test (non-operation)	Shock level:980m/s ² (equal to 100G) Waveform: half sinusoidal wave,6ms. Number of shocks: one shock input in each direction of three mutually perpendicular axes for a total of three shock inputs.	



Messrs.					
Product Specification	Model:	MTF-T070ACSLP-LB	Rev. No.	Issued Date.	Page.
			<i>E</i>	<i>Oct.19, 07</i>	<i>19 / 23</i>

8. PRECAUTIONS





8.1 Operation

Burn-in sometimes happens when the same character was displayed at along time. Therefore, to prevent Burn-in, it is recommended to set up a Screen-saver function.

8.2 Safety

The liquid crystal in the LCD is poisonous, DO NOT put it in your mouth. If the liquid crystal touches your skin or clothes, wash it off immediately using soap and water.



8.3 Handling

	<p>a. The LCD module shall be installed flat, without twisting or bending. b. COF or FPC has narrow pattern width, so easily become open circuit by external force. DO NOT apply pressure to COF or FPC especially in bending area.</p>
	<p>c. To avoid damage in appearance or malfunction, DO NOT subject the module to mechanical shock or to excessive force on its surface.</p>
	<p>d. The polarizer attached to the display is very easy to damage, handle it with care to avoid scratching.</p>
	<p>e. To avoid contamination on the display surface, DO NOT touch the display surface with bare hands. f. Provide a space so that the LCD module does not come into contact with other components.</p>



Messrs.

Product Specification	Model:	MTF-T070ACSLP-LB	Rev. No.	Issued Date.	Page.
			E	Oct.19, 07	20 / 23

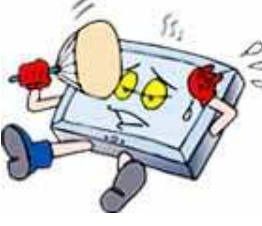
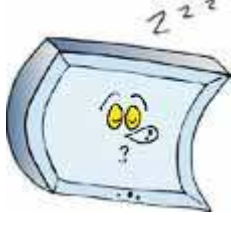
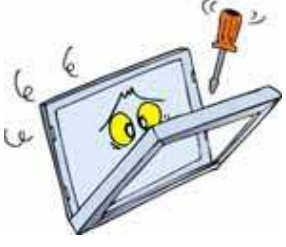
	<p>g. To protect the LCD panel from external pressure, put covering glass (acrylic board or similar board) to keep appropriate space between them.</p>
	<p>h. Be careful for condensation at sudden temperature change. Condensation makes damage to polarizer or electrical contacted parts. And after fading condensation, smear or spot will occur.</p>
	<p>i. Property of semiconductor devices may be affected when they are exposed to light possibly resulting in malfunctioning of the ICs. To prevent such malfunctioning of the ICs, your design and mounting layout done are so that the IC is not exposed to light in actual use.</p>
	<p>j. Strong light exposure causes degradation of color filter. It may not recover</p>
	<p>k. DO NOT contact with water to avoid Metal corrosion.</p> <p>l. When it is not in use, the screen must be turned off or the pattern must be frequently changed by a screen saver. If it displays the same pattern for a long period of time, brightness down/image sticking may develop due to the LCD structure.</p>
	<p>m. Never disassemble LCD product under any circumstances. If unqualified operators or users assemble the product after disassembling it, it may not function or its operation may be seriously affected.</p>



Microtips Technology Inc.

Messrs.					
Product Specification	Model:	MTF-T070ACSLP-LB	Rev. No.	Issued Date.	Page.
			E	Oct.19, 07	21 / 23

8.4 Static electricity

Since a module is composed of electronic circuits, it is not strong to electrostatic discharge.

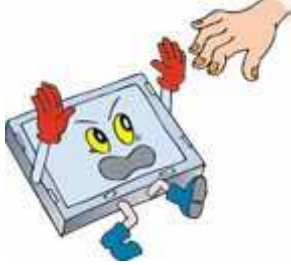
	<ol style="list-style-type: none"> The LCD module shall be installed flat, without twisting or bending. Ground soldering iron tips, tools and testers when they operate. Ground your body when handling the products. DO NOT apply voltage to the input terminal without applying power supply. DO NOT apply voltage that exceeds the absolute maximum rating. Store the products in an anti-electrostatic container. Peel off protect tape, attached to polarizer, slowly to minimize ESD damage.
---	--

8.5 Storage

	<p>Store the products in a dark place at +5 ~ +25 degree C, low humidity (50%RH or less). DO NOT store the products in an atmosphere containing organic solvents or corrosive gases.</p>
--	--

8.6 Cleaning

	<ol style="list-style-type: none"> DO NOT wipe the polarizer with dry cloth, as it might cause scratch. Wipe the polarizer with a soft cloth soaked with petroleum IPA, other chemical might damage.
---	--

8.7 Waste

	<p>When dispose of LCD module, manage it at the production waste according to the relevant laws and regulations.</p>
---	--



Messrs.					
Product Specification	Model:	MTF-T070ACSLP-LB	Rev. No.	Issued Date.	Page.
			<i>E</i>	<i>Oct.19, 07</i>	<i>22 / 23</i>

9. WARRANTY

This product has been manufactured to your company's specifications as a part for use in your company's general electronic products. It is guaranteed to perform according to delivery specifications. For any other use apart from general electronic equipment, we cannot take responsibility if the product is used in medical devices, nuclear power control equipment, aerospace equipment, fire and security systems, or any other applications in which there is a direct risk to human life and where extremely high levels of reliability are required. If the product is to be used in any of the above applications, we will need to enter into a separate product liability agreement.

- 1 We cannot accept responsibility for any defect, which may arise from additional manufacturing of the product (including disassembly and reassembly), after product delivery.
- 2 We cannot accept responsibility for any defect, which may arise after the application of strong external force to the product.
- 3 We cannot accept responsibility for any defect, which may arise due to the application of static electricity after the product has passed your company's acceptance inspection procedures.
- 4 We cannot accept responsibility for industrial property, which may arise through the use of your product, with exception to those issues relating directly to the structure or method of manufacturing of our product. Microtips-origin longer than one year from Microtips production.

10. DIMENSIONAL OUTLINES

- See the next page.....



Microtips Technology Inc.

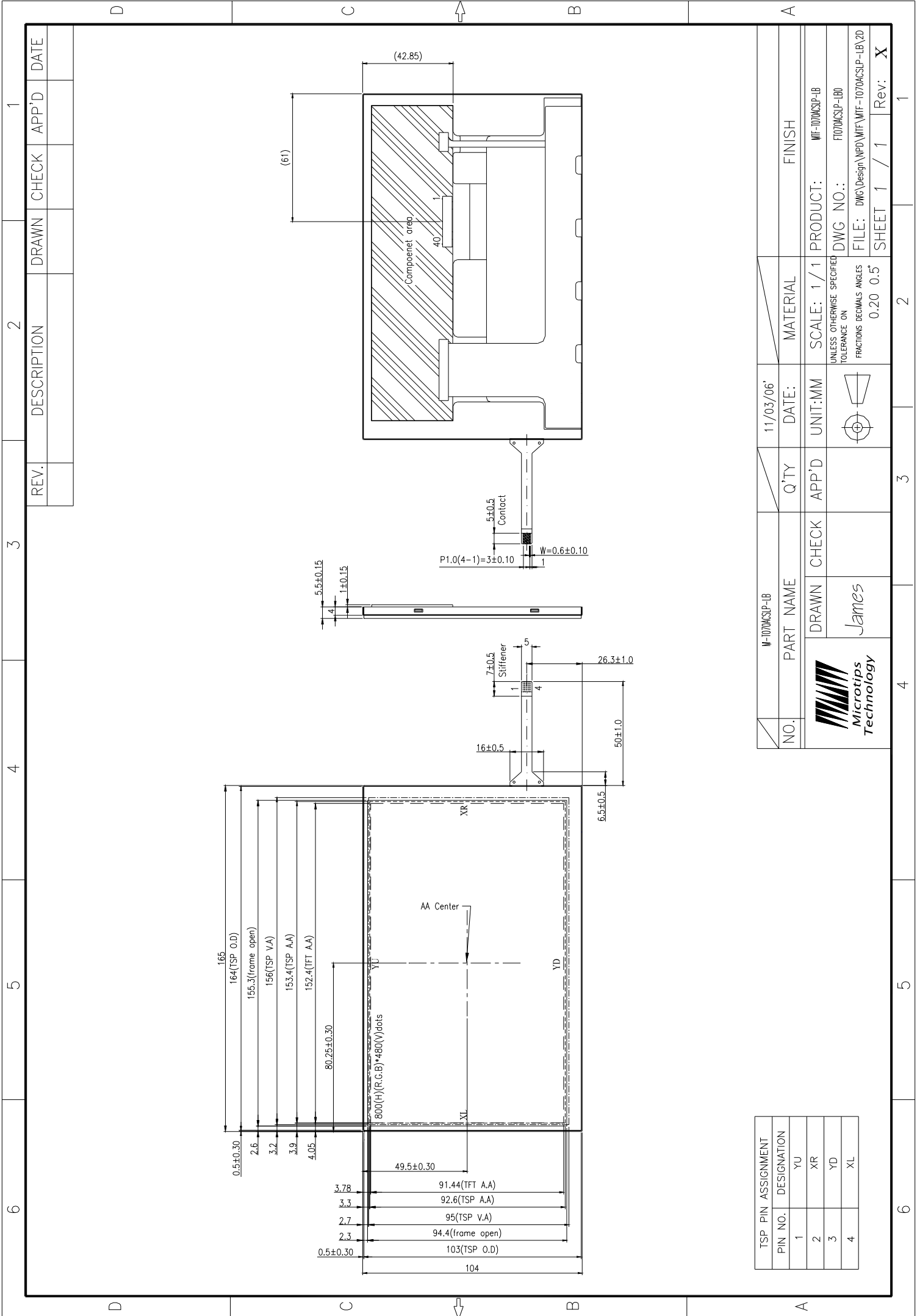

REV.	DESCRIPTION	DRAWN	CHECK	APP'D	DATE

NO.	PART NAME	Q'TY	DATE:	MATERIAL	FINISH
	W-1070ACSP-LB		11/03/06		

DRAWN	CHECK	APP'D	UNIT:MM	SCALE: 1/1	PRODUCT:
James					W-1070ACSP-LB

UNLESS OTHERWISE SPECIFIED TOLERANCE ON FRACTIONS DECIMALS ANGLES	DWG NO.:	FILE:	SHEET	Rev:
0.20 0.5		DWC:\Design\WPD\MIF-1070ACSP-LB\2D	1 / 1	X

TSP PIN ASSIGNMENT	PIN NO.	DESIGNATION
	1	YU
	2	XR
	3	YD
	4	XL

Mouser Electronics

Authorized Distributor

Click to View Pricing, Inventory, Delivery & Lifecycle Information:

[Microtips Technology:](#)

[MTF-T070ACSLP-LB](#)